

L形集水枳縁塊 300斜(10cm~2cm)

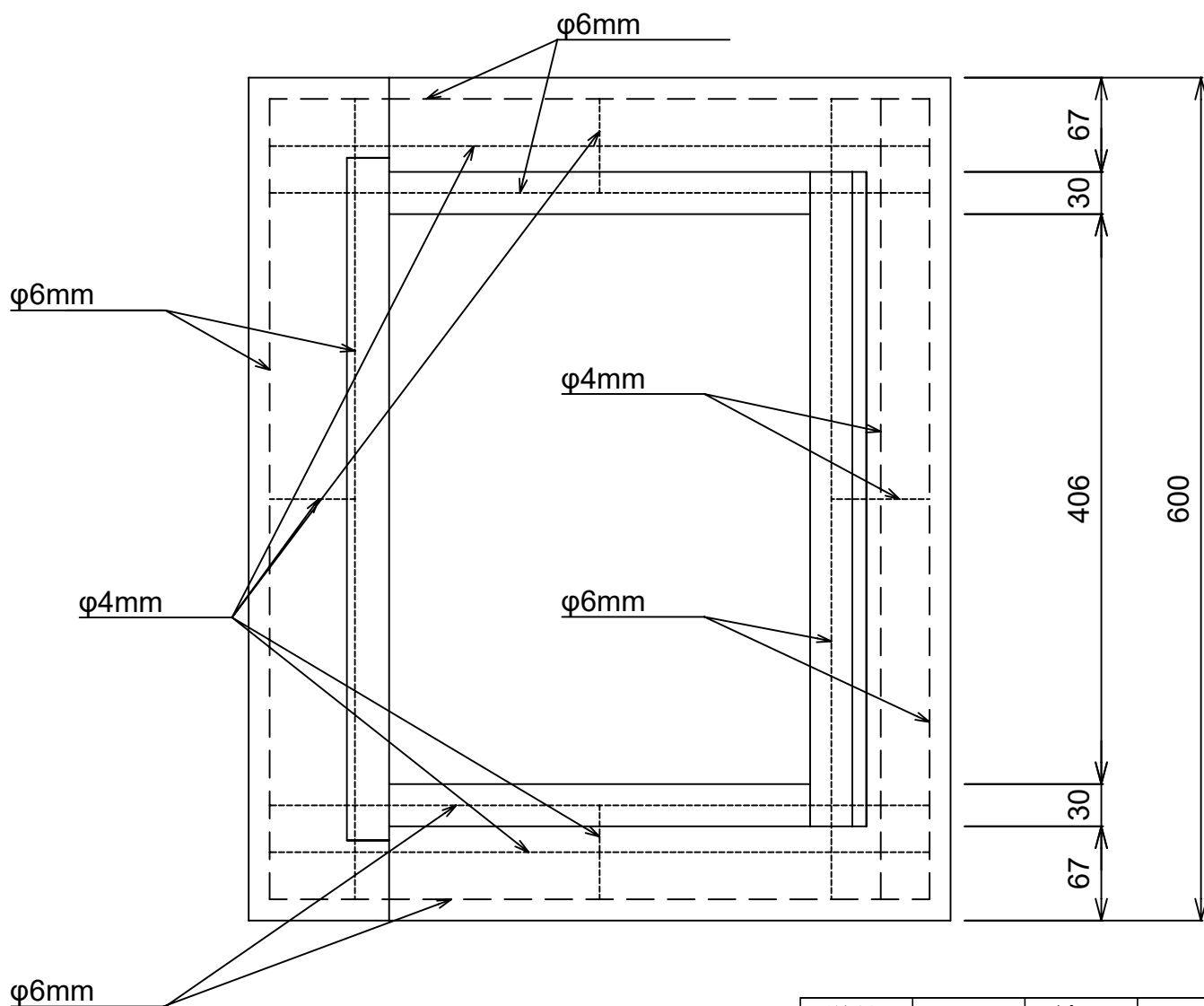
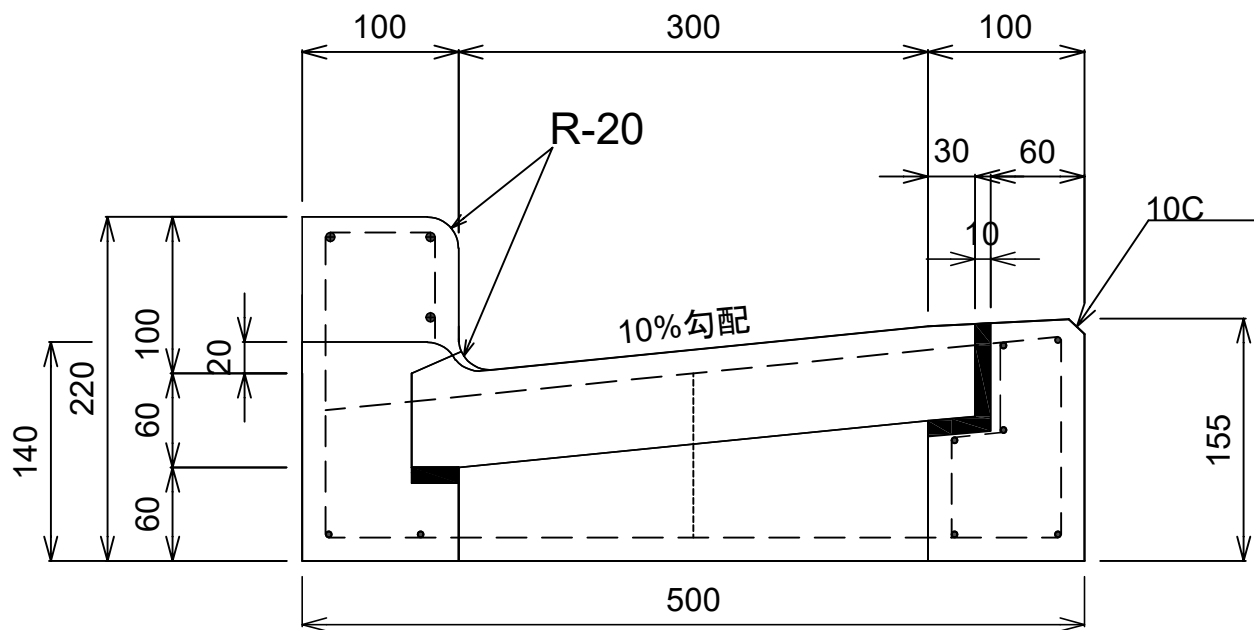

単位	mm	縮尺	1/5
参考重量		61 kg	
 イルコン工業株式会社			