

L形集水桝縁塊 250B

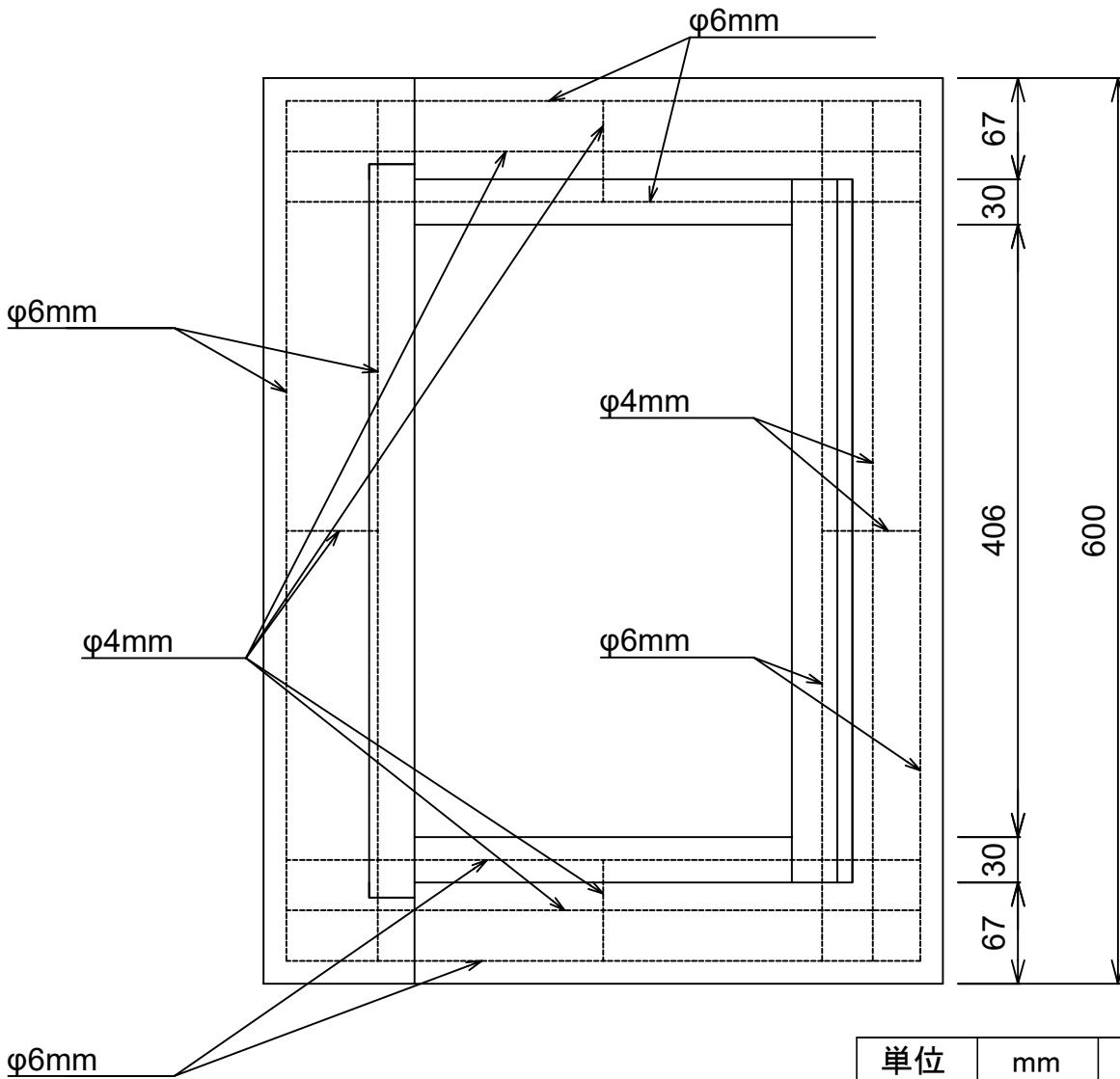
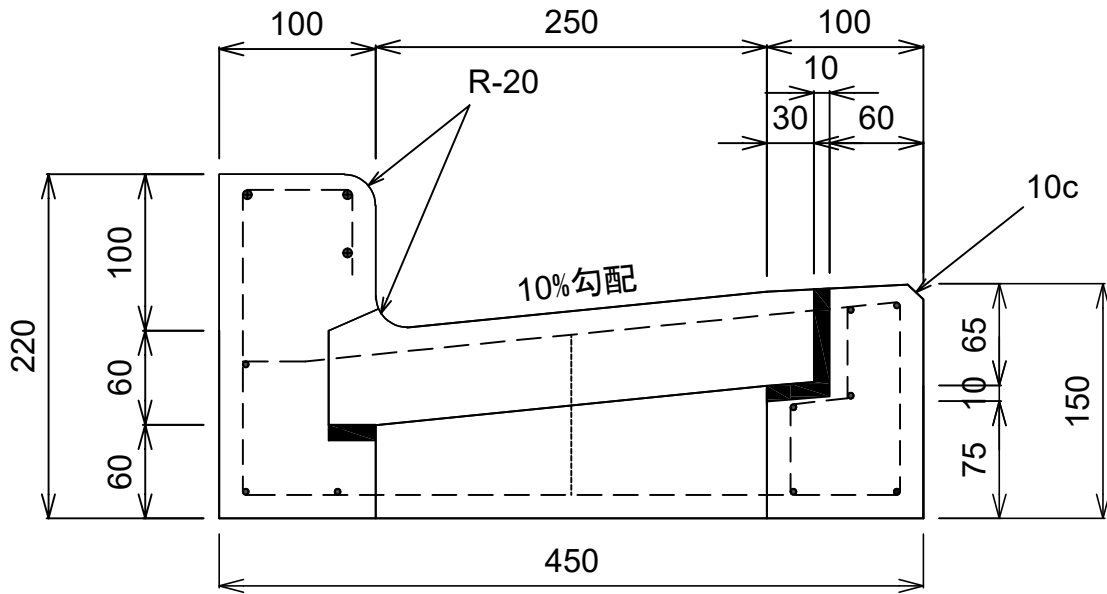

単位	mm	縮尺	1/5
参考重量		63 kg	
 イルコン工業株式会社			